

TOP VIEW

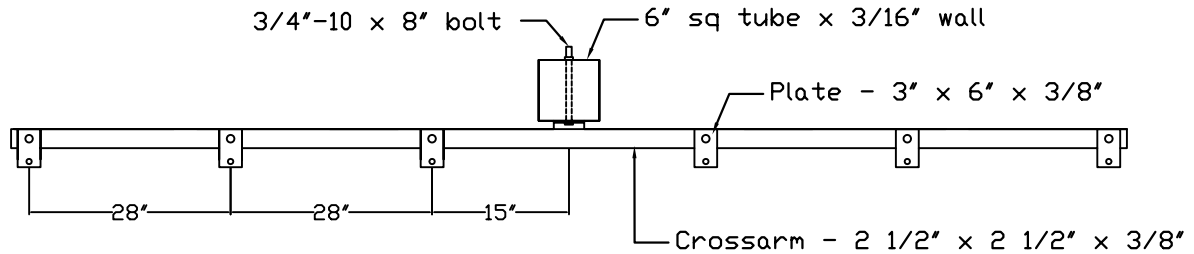

FRONT VIEW

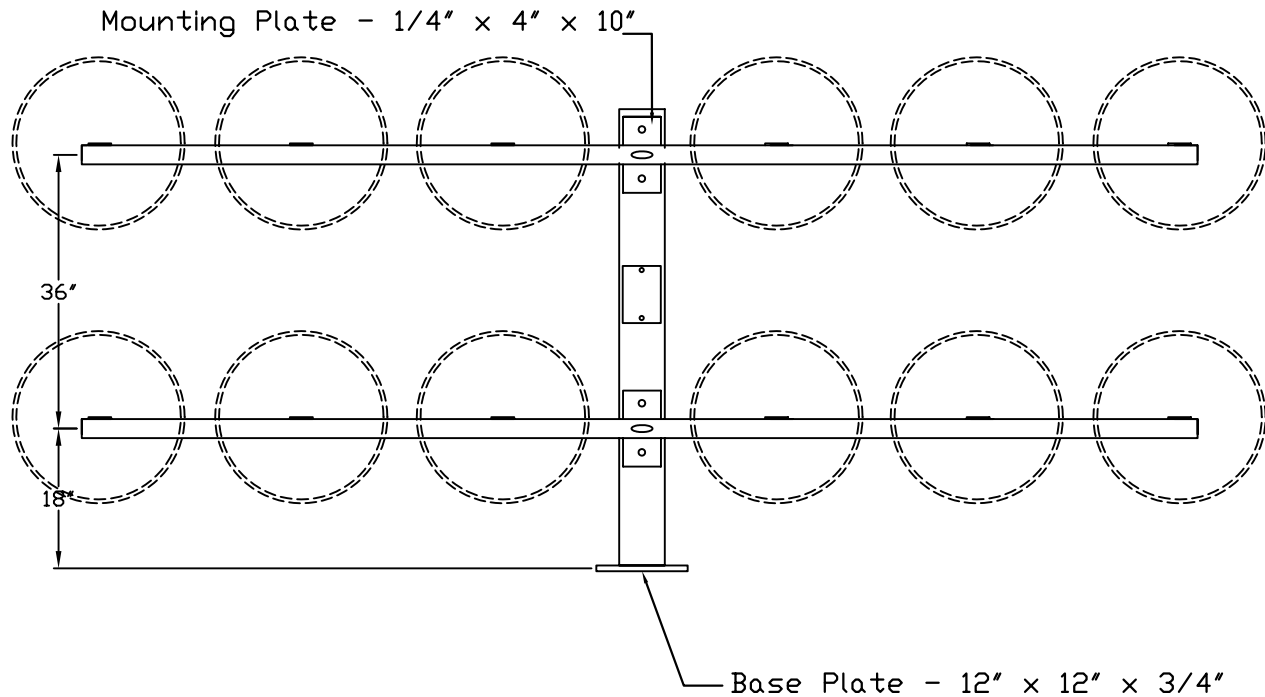

** Hot-Dipped galvanized
after fabrication to
ASTM A123 specifications

** NOT TO SCALE



9609 BECK CIRCLE
AUSTIN, TX 78758-5401
PHONE: (512) 977-8880
TOLL FREE: (800) 500-3161
FAX: (512) 977-8882

DATE:
12-16-03

REV.: CHECKED BY:

DRAWING NUMBER:
TDA 12 FIX

DRAWN BY:
WRW

12 FIXTURE CROSSARM
ASSEMBLY