

# TOP VIEW

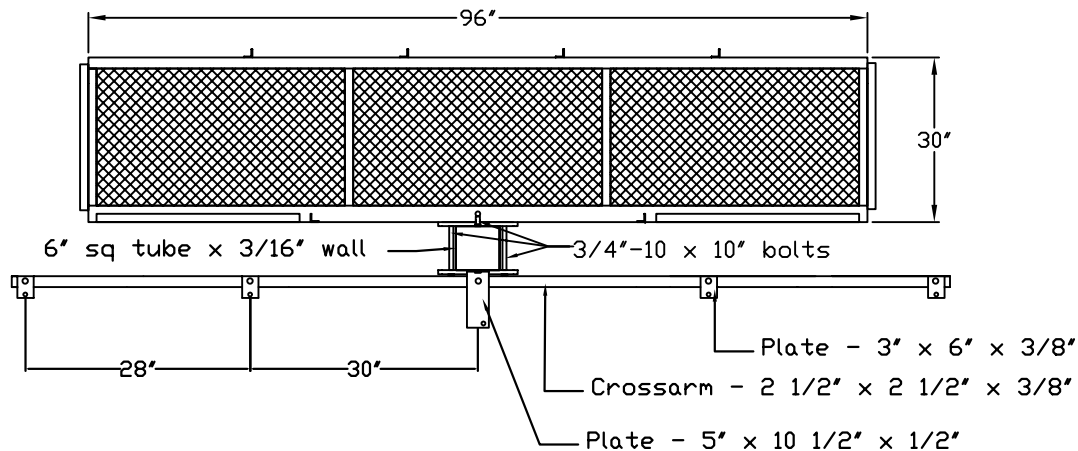

# FRONT VIEW

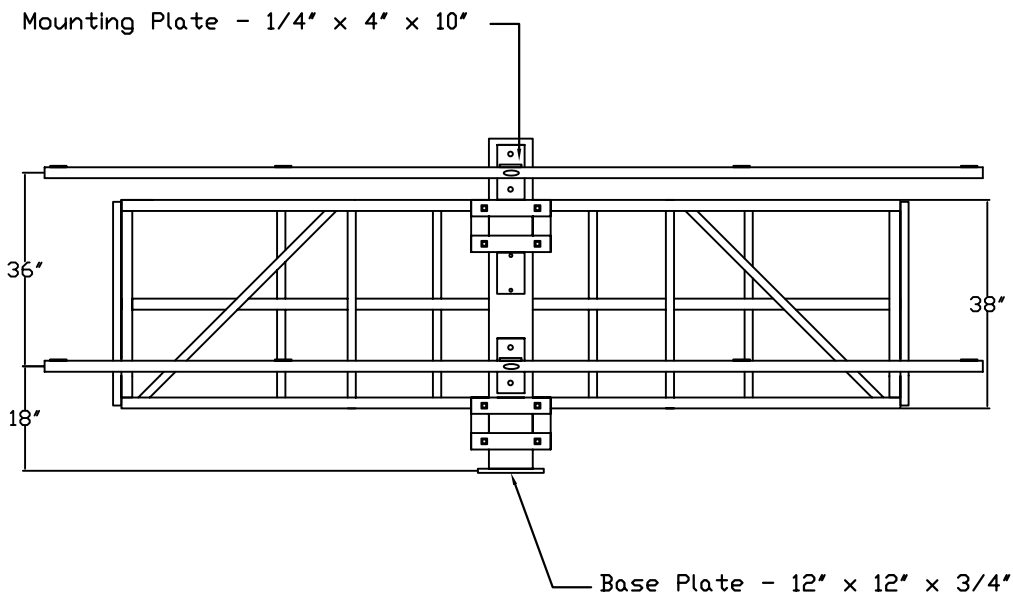

# SIDE VIEW

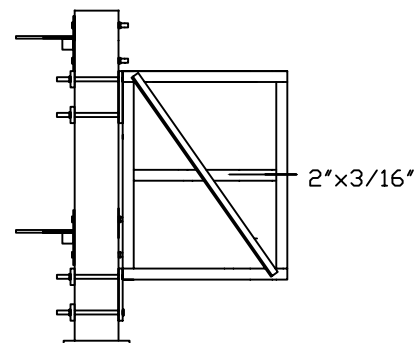

\*\* Hot-Dipped galvanized after fabrication to ASTM A123 specifications

\*\* NOT TO SCALE



9609 BECK CIRCLE  
 AUSTIN, TX 78758-5401  
 PHONE: (512) 977-8880  
 TOLL FREE: (800) 500-3161  
 FAX: (512) 977-8882

DATE: 12-12-03	REV.:	CHECKED BY:
DRAWING NUMBER: TDA 10 FIX/CAGE	DRAWN BY: WRW	

10 FIXTURE CROSSARM &  
 CAGE ASSEMBLY